

B90TV

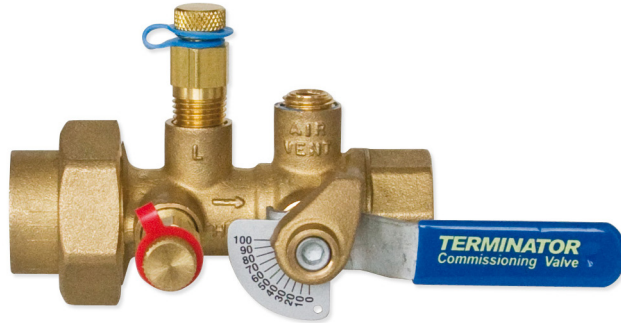

Description

The Terminator commissioning valve (TCV) is a combined venturi measuring device and regulating ball valve. Each valve size comes with an option to change the venturi depending on the flow and design approach.

The 1/2" TCV is suitable for most typical flow rates found in fan coil units including those that would be commonly sized at 3/4". Sizes 1/2" and 3/4" fit a ball with a special high flow rate profile while higher sizes have a full port ball. Sizing of commissioning valves is usually carried out to provide differential pressure readings between 2 and 10 kPa on a manometer, although the venturi can also be used to introduce a significant amount of resistance if required into the system design. For an accurate control, the valve size must have enough authority: authority calculation has to be carried out selecting the valve.

The Venturi is patented US RE37617 E and the ball is a reduced port ball.

Integrated Union

Whenever a terminal unit is installed it requires unions on the inlet and outlet to allow for servicing. To save time, space and cost, Pettinaroli have included a union in the design of the valve.

Air Vent Tapping

In making the most comprehensive featured commissioning valve available today, we took advantage of the low velocity area which surrounds the ball, and placed an air vent tapping on it.

End Connections

Standard end connections are female BSP from 1/2" to 2".

Venturi Options

A wide range of flows can be accommodated as at least two options are available for each valve size.

Commissioning Set

A commissioning valve installed in heating and cooling circuits is primarily used to measure flow using a differential pressure manometer. It allows the commissioning engineer to see how the flows within the circuit are distributed. Once the flows are established and the Index circuits identified, then the secondary use of the commissioning set, that of regulation, adding resistance to circuits that have too much flow. The amount of resistance added to circuits is dependant on many variables such as the flow, the resistance and layout of the fan coil, the pipe and the pipe lengths between fan coils.

Sizing for flow

Sizing of commissioning valves is usually carried out to give differential pressure readings between 2 and 10 kPa on a manometer. Historically this very general rule was acceptable as it allowed a mercury 'U' tube manometer to be filled with fluorocarbon in place of the mercury and so allow quite accurate readings to be taken of smaller pressure differentials.

The development of accurate electronic differential pressure measurement devices has meant that some consultants prefer design signals above 2 kPa as readings on the index circuit might not be visible or accurate enough if sized to 1 kPa signal. Low loss venturi's as fitted in balancing products give high signals with low losses and are becoming the preferred option of some designers.

The interchangeable venturi system allows the designer to over

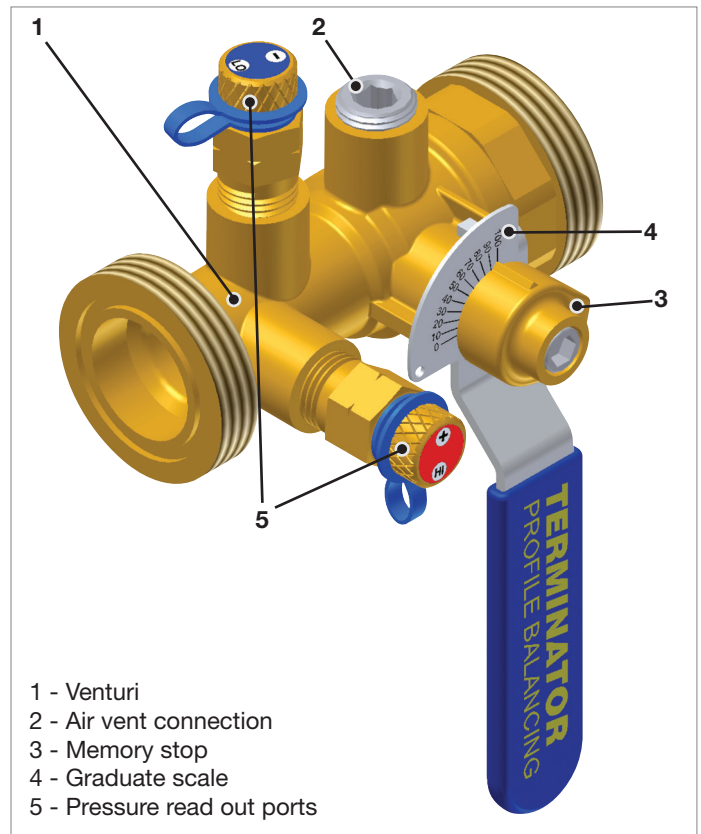

- 1 - Venturi
- 2 - Air vent connection
- 3 - Memory stop
- 4 - Graduate scale
- 5 - Pressure read out ports

size mains pipework to reduce the pump head required for the system. By fitting a smaller venturi the flow can be still be accurately measured without the typical and expensive reduction pipework as is common with most manufacture's fixed orifice devices.

Variable Volume

This principle can be put to very good use on variable volume systems. Pipe sizing on variable volume systems where the pump head is required to be kept at a minimum can be designed using a size larger pipework with Flow Measuring Venturi's. The pump head required is reduced because the pipe losses are reduced. The smaller pump means that differential pressure through out the system is not as significant. Two port control valves typically affected by high differential pressures might not require differential pressure control valves.

Using Venturi's to remove head

The Terminator Commissioning Valve has five different sizes of venturi's which may be fitted. These interchangeable venturi's create different amounts of resistance depending on flow rates.

If resistance can be added using a venturi rather than regulating a valve then the system could be more self balancing. This would allow DRV valves to be more open and less likely to block as is the case with low flow valves currently found on the market.

The interchangeable venturi can also be used to take out a significant amount of the resistance when designed into the system. This only then leaves the commissioning engineer fine tuning on the ball valve.

Technical features

Temperature	Working pressure max.	Stroke	Thread	Medium
-10 ÷ 120 °C	2500 kPa / 25 bar	90°	Rc ISO 7/1	Water / Water+glycol 50%

Product	Thread size	Venturi size [mm]	Kvs	Kv valve
B90TV	1/2"	3	0.36	0.38
B90TV	1/2"	4.25	0.71	1.12
B90TV	1/2"	6	1.38	2.29
B90TV	1/2"	7.5	2.20	3.27
B90TV	3/4"	9	3.25	4.50
B90TV	3/4"	12	6.00	5.50
B90TV	1"	10	4.10	5.90
B90TV	1"	14.50	8.80	19.5
B90TV	1 1/4"	13	7.00	13.30
B90TV	1 1/4"	19	14.70	31.00
B90TV	1 1/2"	15	9.50	18.00
B90TV	1 1/2"	22	19.20	47.00
B90TV	2"	18	12.50	26.50
B90TV	2"	31.50	42.00	78.50

Headloss

The headloss (Δp) attributed to a Terminator Commissioning valve inserted into a pipeline can be calculated by the reference formula:

$$\Delta P = \left(\frac{Q}{Kv} \right)^2$$

Where:

- Q = flow in m²/h,
- Δp = headloss in bar,
- Kv is provided from the table beside (Kvs)

Materials

	Material
Ball (A)	Brass CW617N
Body (B)	Brass CW617N
Lever (C)	Steel with Deltaproteck. PVC
Seat (D)	PTFE
Stem (E)	Brass CW614N
Pressure port (F)	Brass CW617N
Memory stop (G)	Brass CW617N
Union & Nut	Brass CW617N
Venturi	Brass CW614N
O-Rings	FKM

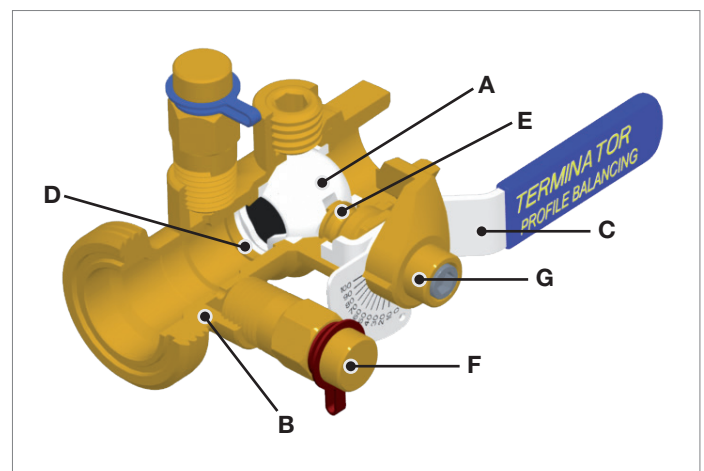

Dimensions

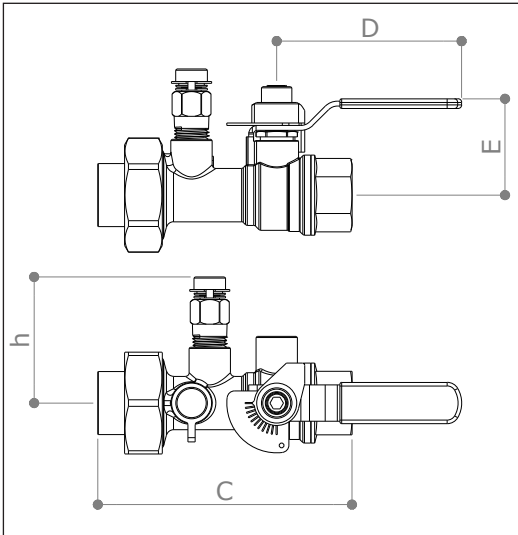

B90TV					
Size	C (mm)	D (mm)	E (mm)	h (mm)	Weight (kg)
1/2"	123.5	75	52	52	0.60
3/4"	126	75	52	52	0.60
1"	149	95	55	55	1.00
1 1/4"	171	120	59	59	1.40
1 1/2"	191	120	60	60	2.00
2"	280	150	66	66	3.00

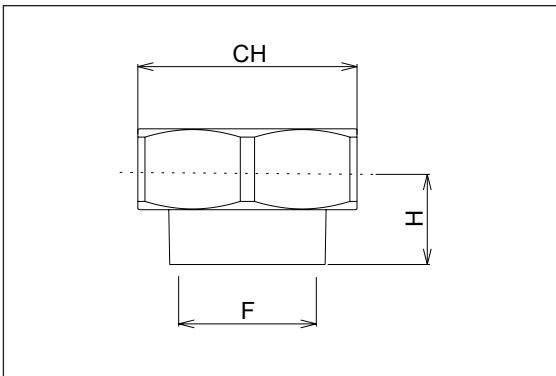

FEMALE CONNECTION			
Size	CH (mm)	H (mm)	F (mm)
1/2"	42	18,5	1/2"
3/4"	42	20	3/4"
1"	53	24	1"
1 1/4"	65	26	1 1/4"
1 1/2"	73	27	1 1/2"
2"	89	31,5	2"

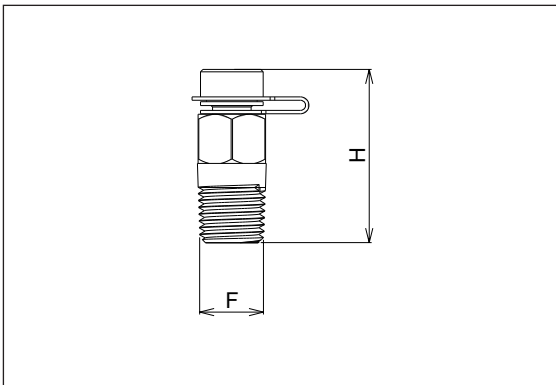

T90RB		
Size	H (mm)	F (mm)
-	36	1/4 NPT

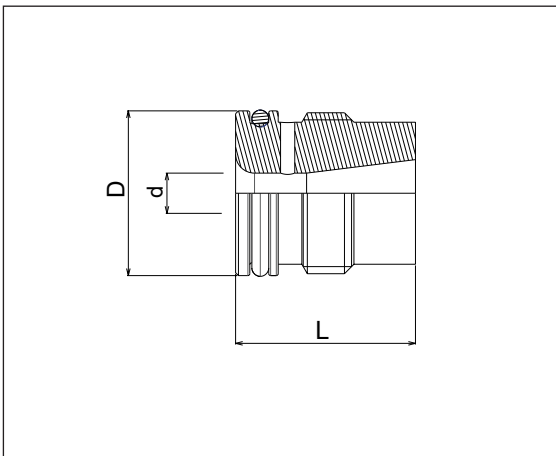

VENTURI			
Size	D (mm)	d (mm)	L (mm)
1/2" x 3	17,4	3	19
1/2" x 4	17,4	4	19
1/2" x 6	17,4	6	19
1/2" x 7,5	17,4	7,5	19
3/4" x 9	17,4	9	19
1" x 10	20,8	10	19
1 1/4" x 13	27,7	13	25,3
1 1/2" x 15	32,7	15	33,3
2" x 18	41,7	18	42,5
2" x 25	41,7	25	42,5



Commissioning and pressure loss

Commissioning

One of the benefits of using a quarter-turn balancing ball valve is that it can accommodate different components, in order to match different flow rate ranges.

Once the valve is fit, flow rate can be set by moving the lever. The design flow rate must be measured by the Venturi and the digital manometre MDPS2. Please set properly the manometre indicating the valve type, size and Venturi. Be aware that the valve has a reduced port ball.

When the flow rate is set, turn and lock the memory stop device.

Interchangeable Venturi

Terminator manual balancing valve series accommodates a special patented technology that allows flow rate measurement at any condition.

Size of venturi can be changed so that ΔP taken from the orifice is always fit for the available gauge or reading instrument.

At the same time there are regulations that limit the amount of pressure losses generated by regulating means (such as balancing valves).

The pressure characteristic of the venturi is such that combines two benefits at the same time (Fig.1)

Differential pressure signal given by venturi (ΔP_{Vs}) is higher than total differential pressure absorbed by the balancing valve (ΔP).

This unique feature allows at the same time good reading signal and low total energy losses across the valve.

Furthermore, it is well known that accuracy of a fixed orifice device is better than a variable orifice device and remains constant throughout its measuring range (Fig.2).

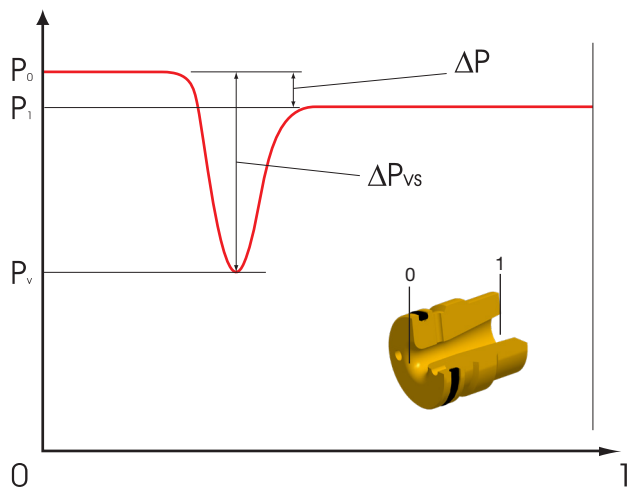

Fig. 1

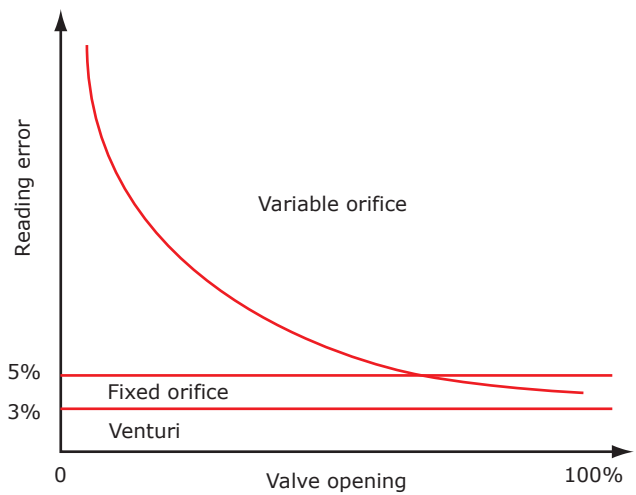
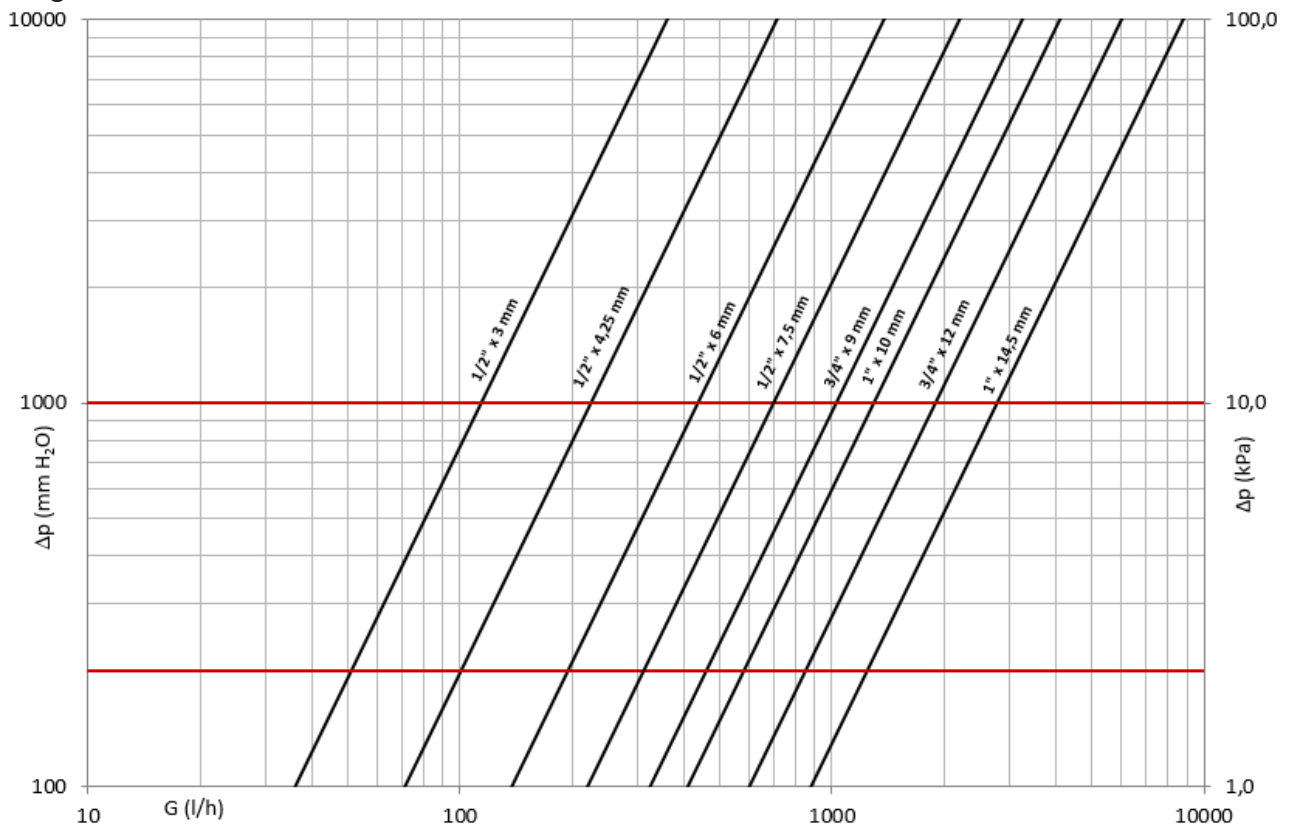
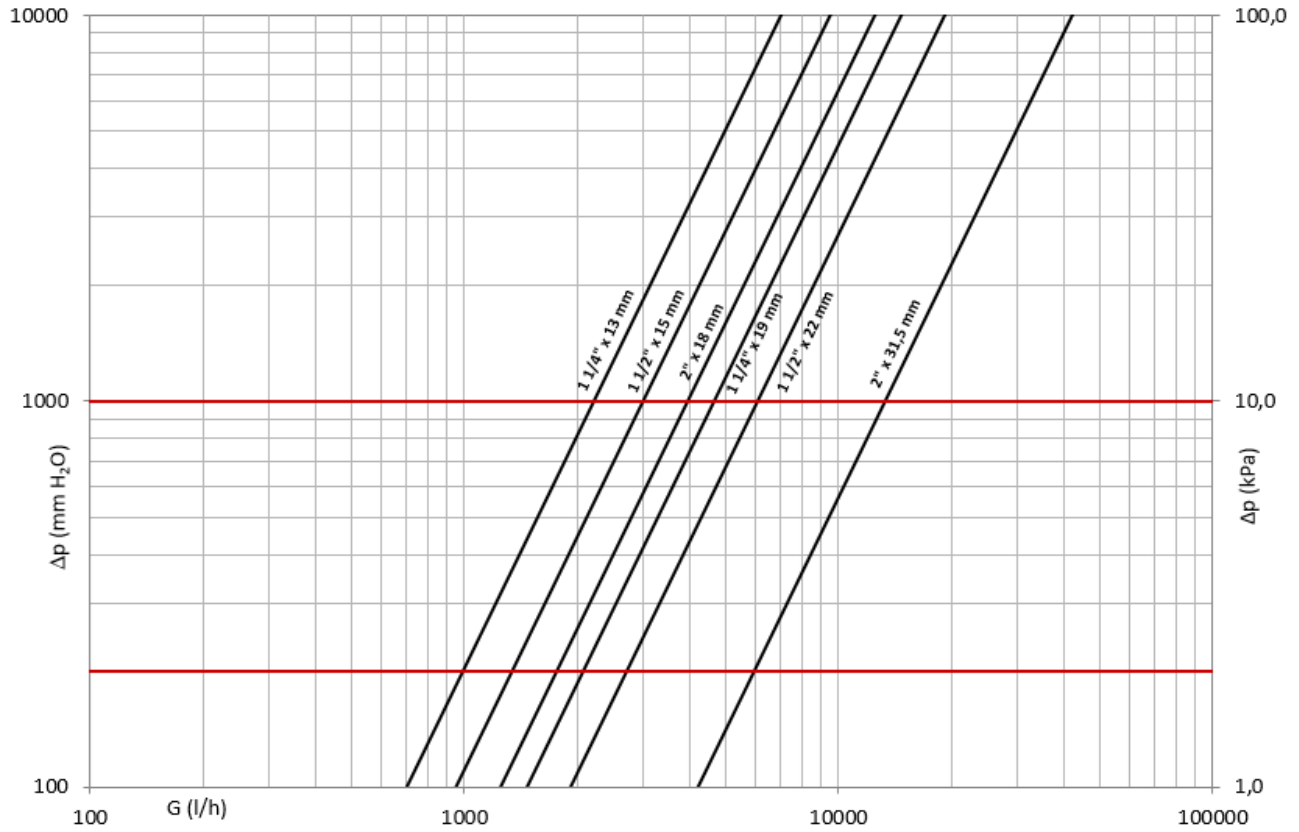

Fig. 2

Venturi signal





Total pressure loss chart

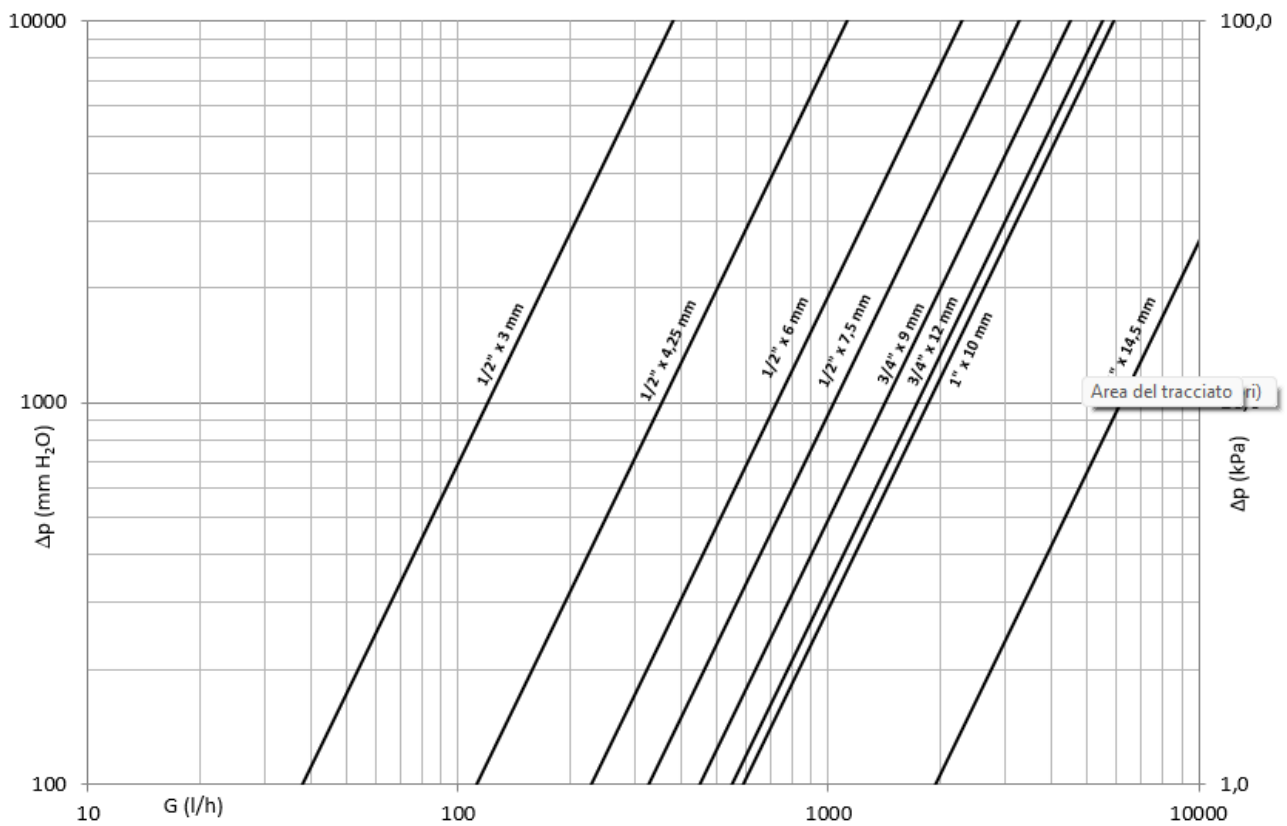

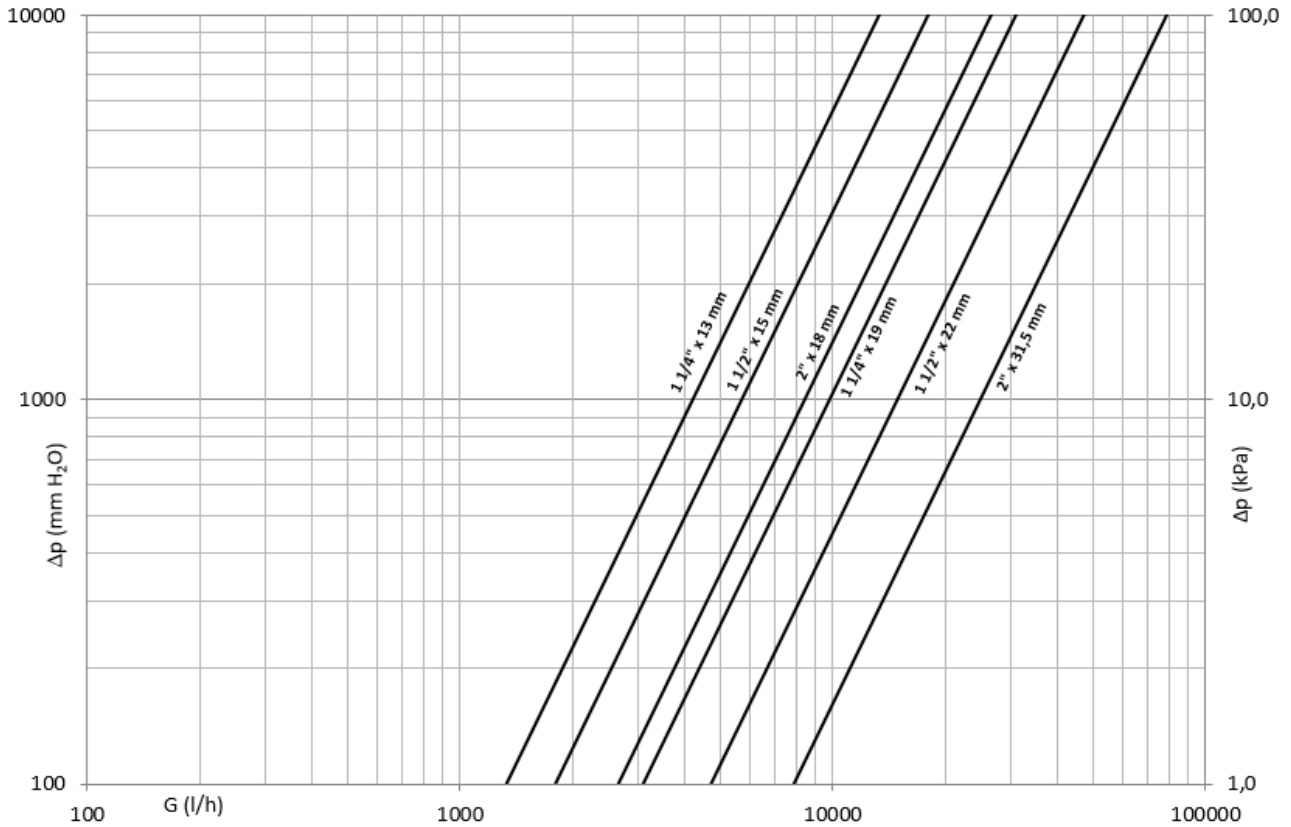

Configuration

Step 1 - Select pipe connections

1/2" - 2", calculate and check the authority.

Step 2 - Select venturi size

Venturi must be selected in order to limit maximum headloss across the valve and maintain high signal.

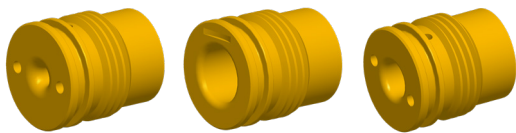

Step 3 - Select union connections

Female connection is supplied by default, the male one (1020B just for 1/2" and 3/4") has to be ordered separately.

Male

Female

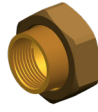

Generals

Pettinaroli does not accept any liability for improper or wrong use of this product.

Always protect the pressure regulator by using strainers upstream of the valve and, in any case, make sure water quality complies with UNI 8065 standard. Fratelli Pettinaroli suggests to follow recommendations of VDI 2035/1 too. Maximum suggested content (total) content of Iron and Copper should be: Fe < 0.5 mg/kg and Cu < 0.1 mg/kg.

*The product color may be different with the actual product color due to printing procedure. *The appearance and specifications may change with no prior notice for improvement. *The data and photo should not be used without permission of the copyright holder.



Fratelli Pettinaroli Spa

Via Pianelli, 38 - 28017 San Maurizio d'Opaglio (NO) - Italy

Tel. +39 0322 96217 - +39 0322 96545 - Fax +39 0322 96546

info@pettinaroli.com - www.pettinaroli.com

